

2008-1

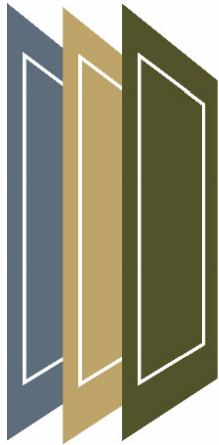

US CUSTOMIZED
F I N I S H E S

MDF DOORS

PRODUCTS AND SPECIFICATIONS

US Customized Finishes LLC

1175 Highway 23, Suite 8, Suwanee, GA 30024

Local Phone: 770-271-1266 Toll Free Phone: 1-800-916-8639

Local Fax: 770-271-8793 Toll Free Fax: 1-800-473-1462

Email: service@uscustomized.com Website: www.uscustomized.com

QUICK REFERENCE SHEET

Raised Panel Designs

Square Raised Panel

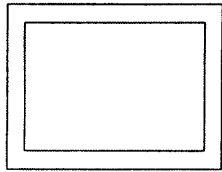

SQUARE

Designer Panel

Designer panels available on most door styles at a small fee

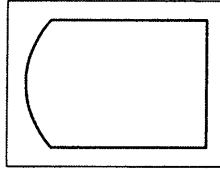

ARCH

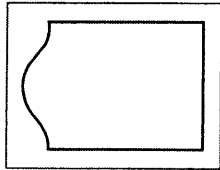

CATHEDRAL

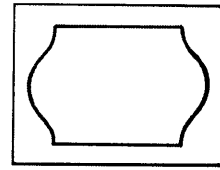

DOUBLE CATHEDRAL

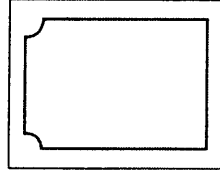

PROVINCIAL

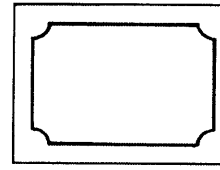

DOUBLE PROVINCIAL

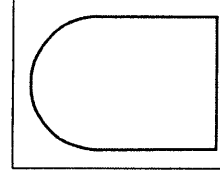

FULL ROUND

Standard Edge Treatments

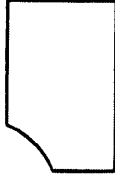

#10 COVE



C2

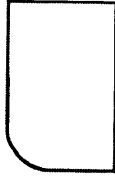

#20 1/4" ROUND OVER



#30 1/4" ROUND OVER WITH 1/16" REVEAL



HEDGEWOOD



1/8" ROUND OVER



#50 SQUARE



ITALIA

Edge Modifications

These edge modifications are available at an additional fee. See the General Information section for more details. Certain limitations may apply.

Angle Cut - 45°

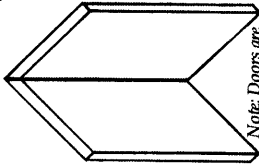

Inside Corner Face Cut

Note: Doors are not assembled

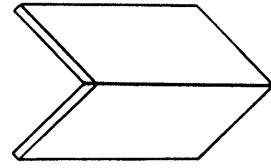

Outside Corner Back Cut*

**Not available on products with melamine back*



Bullnose Edge*

**Not available on products with melamine back*



Hidden Finger Pull

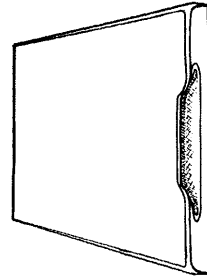

Finger Pull Center Placement

Offset Lip

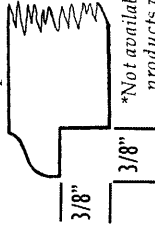

3/8"

3/8"

C2 edge with 3/8" offset*

**Not available on products with melamine back*

This booklet includes information on our MDF door and drawer products, moldings, valances, etc. This booklet should be used in conjunction with pricing information received either directly from the manufacturer or from your local representative.

Every effort has been made to assure accuracy, however, the manufacturer reserves the right to change any or all prices and specifications without prior notice and assumes no liability for errors or omissions as they may occur. It should be noted that drawings included in this catalog are not to scale and should be used only as a guide.

TABLE OF CONTENTS

Avanti Series	5	Payments	17
BCC Series	6	Prism (Glass) Doors	12
Bead Board	9, 11	RC 100 Series	5
Chesapeake Series.....	6	RC 200 Series	5
Classic (Slab) Series	4	RC 300 Series	5
Customer Information Sheet.....	17	RC 400 Series	5
5-Piece Doors	8-9	RC 500 Series	5
Foil Material.....	11	Rosettes	10-11
Fluted Molding	10-11	Shaker Series	7
General Information	2-3	Slab (Classic) Series.....	4
Glass Doors	12	Specialty Items.....	3
Glazed Finishes	9	SQ Series	6
Headers.....	11	SQ 300 Series	6
International Series	4	Valances	11
Lexington Series	6	V-Groove Doors.....	4
Ltd. Warranty	Back Cover		
Moldings	10-11		
Optical (Glass) Doors	12		
Order Information	13-16		

This catalog has been developed by U.S. Customized Finishes, Inc. for the benefit of its clients and prospects. Duplication of these materials (excepting the order forms enclosed) is prohibited without permission of U.S. Customized Finishes, Inc. Copyright pending.

General Information - Please review the following for more information on our product line and processes.

Angle Cut Doors - This treatment is often used when 2 doors are "joined together" (for example, a Lazy Susan unit). There is an additional fee for this edge treatment. See inside front cover for more information. *Note: Doors are not assembled.*

Appliance Panels - Panels can be produced for appliances such as a refrigerator or dishwasher. We do not maintain a listing of appliance specifications so you must provide the sizes needed. We recommend ordering a 1/4" thick piece to fit inside the grooves and another 1/2" piece (generally ordered approximately 1" less in width and height) to fit on top of the 1/4" piece. These items are shipped as two pieces.

Back Treatments - We stock a variety of MDF finishes and thicknesses allowing us to offer matching backs on many of our thermofoil products. A small fee will apply. A white melamine back is standard on thermofoil products and will be used unless specified otherwise.

Bead - The bead is the transition from the rail and stile to the flat part of the routed area. The design of this bead will vary from one door style to another. The dimension of this bead is not included in the standard dimensions given for rails and stiles, unless noted.

Bull Nose - A decorative bull nose can be applied at an additional fee. This edge is not available on thermofoil products or on products ordered with a melamine back. See the inside front cover for more information.

Drawer Fronts - Most designs are available with routed drawer fronts to match the door design. Unless noted, all 1-piece routed drawer fronts will be standard with a 1" top and bottom rail. Five-piece drawer fronts do not have modified rails (see special info regarding 2002 and 2005 Series). Five-piece drawer fronts must be ordered using a bead board or flat insert.

Edge Profiles - There is no additional charge to apply a standard edge (see inside front cover). If you need an edge that is not shown, we invite you to call for more information. A small set up fee may be charged to defray the additional set up costs involved.

Finger Pull (Center) - See the inside front cover for a drawing of this finger pull. We recommend a 1/4" roundover edge with this type of finger pull. There is an additional fee to apply this treatment.

Finger Pull (Hidden) - See the inside front cover for a drawing of this pull. There is an additional fee to apply this special treatment. Please use a C2 edge for best results. This pull will not work in a frameless cabinet installation. You must allow at least 1/2" between doors in order to use this pull.

Foil Material - Foil material can be purchased to cover your cabinet boxes and end panels. See page 11 for more information.

Glass - Glass doors can be ordered in a variety of styles including open frames (Prisms) and mullions (Optical doors). Glass is not included.

Glazed Doors - Our glazed MDF doors are manufactured using a variety of techniques to achieve a high quality finish. Glazing is currently available on the 2000 Series of 5-piece doors, see page 9. Call the office for more information on available glazes.

Grain Direction - Woodgrain foils are applied vertically on door fronts and horizontally on drawer faces. If you need a special configuration, you must specify this at the time of order.

Headers - Header panels and valances can be purchased to complement your designs. See page 11.

Hinges - No drilling for hinges is provided. Our edge designs are designed to accommodate most types of hinges including most European type cup hinges. No guarantees are made or implied regarding hinge compatibility. Caution must be used when setting up to drill and care should be taken to protect the faces. Please use a clean, padded surface especially when drilling painted or foiled finishes.

MDF/Melamine - All products are manufactured using high quality MDF to assure the best quality product and finish. Melamine is created by bonding melamine resin impregnated decorative papers to MDF. This process takes place under heat and pressure to create an extremely durable finish that is suitable for many different applications including the manufacturing of cabinet doors and drawer fronts. Melamines are available in a variety of finishes and coordinate with many high-pressure laminates and edgbanding materials to allow for design flexibility.

Moldings - Decorative moldings are available and can be purchased unfinished, primed, painted and foiled. Moldings are sold in 8' lengths.

Offset Lip 3/8" - We can offset the backs of your doors for an additional fee. This special feature would not be available for products that are standard with a melamine back. See the inside front cover for more information.

Ordering - Order forms are located in the back of this catalog and can be copied for your convenience. We prefer orders be faxed to avoid error, however phone orders will be accepted. Phone orders will be repeated back and then considered to be correct. Orders can be accepted in decimals, millimeters and inches (down to the 16th). On occasion we may require you to sign off on an order before production can begin.

Paint – We do not carry the proper certifications needed to ship large quantities of hazardous materials (paint). We can ship a “limited quantity”, which is generally a few ounces suitable for “SMALL” touchups. This touch-up is pre-catalyzed in our plant and has a short shelf life. A small bottle of touch up is available at no charge (certain restrictions may apply), however customers will be required to pay all hazardous materials shipping costs. Please call for a quotation on these shipping costs.

Painted Products – Painted products are produced using a variety of techniques including hand sanding to provide a high quality finish. Our top coat is a “40 Sheen” or a Satin Finish. Due to the problematic nature of producing high gloss products, we do not produce a high gloss painted finish. For customers needing a high gloss door, we recommend purchasing our primed door products for further finishing in your shop. Painted products can be cleaned using a damp cloth and a mild detergent if necessary. Abrasive cleaners should never be used. Household spills and excess water should be wiped away as soon as possible to prevent damage.

Panels – Decorative panels with multiple designs can be manufactured to your specifications including rail and stile changes, etc. Please include a sketch whenever ordering intricate panel configurations. Certain size limitations may apply. Panels are made to your specific instructions. If you order a 36” wide panel and need 2 designs, YOU MUST SPECIFY THIS, otherwise only 1 panel will be routed.

Primed – Primed products are produced using a variety of techniques including hand sanding to provide a high quality finish. Even though our primed products are smooth, it is necessary that they be sanded prior to finish coating to allow for a mechanical adhesion of the top coat to the primer base. We urge you to request a sample before proceeding with a new project to make sure that your top coat product will work well with our primer base. One recommendation to new customers is to test a few pieces before proceeding with painting an entire job.

Quotes – We are happy to provide quotations for you review and consideration. Quotes are guaranteed for 30 days.

Rabbit – A rabbit is a small groove cut into the back of our glass doors. This 1/2” wide x 3/8” deep rabbit will give you a ledge to sit your glass or other decorative insert for easy installation. We do not provide glass and we strongly recommend that you wait until after you have received your doors to order your inserts. We do not endorse or provide any method of glass installation. Contact your local hardware distributor for additional information on equipment (clips, plugs, etc.) needed for a safe installation.

Rail – The rail is the horizontal part of the “frame” around the center panel of your door. Please refer to the particular door style for more specific information. Drawer front rails are modified to allow for the shorter heights normally used. Unless otherwise noted, rail dimensions do not include any bead that may be included in your door style. Rail dimensions can be modified to fit your needs at a slight upcharge. A drawing should be included with your order to ensure that these modifications are made correctly.

Rush Orders – We understand that from time to time some jobs may require special attention. Due to the increasing strain that these jobs put on our schedule, a 20% rush fee (or \$10 minimum) will be charged. Additionally, no changes will be allowed on rush jobs once orders are in production.

Sample Kits – Sample kits can be purchased to fit your specific needs. See the insert included or call your customer service representative.

Specialty items – Special items may be available to complement your kitchen and bath designs. CNC routing equipment allows us to produce a variety of designs and custom programs. Please call for more information when you need a special item. A design fee may be charged if special set ups and prototypes are needed.

Stile – The stile is the vertical part of the “frame” around the center panel of your door. Please refer to the particular door style for more specific information. Unless otherwise noted, stile dimensions do not include any bead that may be included in your door style. Stile dimensions can be modified to fit your needs at a slight upcharge. A drawing should be included with your order to ensure that these modifications are made correctly.

Thermofoil – Thermofoiling is a process whereby a thin layer of PVC vinyl is glued onto an MDF board. This process uses a membrane press that heats the vinyl and uses vacuum pressure to pull the vinyl into the designs that have been routed. This process produces a door product that is very durable and economical. Because this door can be manufactured at high production levels, we can offer very competitive pricing on this line of products. Due to the nature of this manufacturing process, slight imperfections may occur from time to time. These slight imperfections are generally not considered to be defects. These products can be cleaned with a damp cloth and a mild detergent if necessary. Abrasive cleansers should not be used. To avoid damage, household spills and excess water should be wiped away as soon as possible.

Unfinished – Unfinished (raw) MDF products are routed and sanded using a flat bed sander to remove any rough spots that may remain. Before priming, it is usually best to do a rough sand to open up the MDF.

Valances – See page 11 for more information on ordering a custom arch valance.

Warranty – See the back cover for information on our limited warranty.

Flat Panel Doors

Our Classic Series is a flat panel (slab) door that can be purchased with your choice of standard edge at no additional charge. We also offer two other designs including our International Series (IS 100 and IS 200) and a collection of V-Groove doors (standard with either a 1/4" Chamfer or Square edge detail). These doors are very economical because little or no routing is required.

Order the Classic Series when you need flat fillers, toe kicks, etc.

Door	Classic	IS 100	IS 200	V-Groove
Minimum Width	2"*	6"	6"	8"
Drawer Front Minimum Height	2" high*	6" high	6" high	6" high
Glass Doors Available Rails and Stiles will be 2 1/4" on all glass doors unless otherwise specified.	YES	YES	YES	YES

Dimensions noted above are for reference only and should be used as a guideline when ordering. Unless otherwise noted, all doors are 3/4" thick. All drawings are for illustration and are not drawn to scale.

*Dimensions may vary depending on edge detail.

CLASSIC

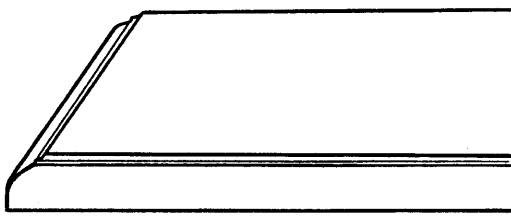

Shown with Hedgewood Edge

IS 100

Shaped on the vertical dimensions of the door only.

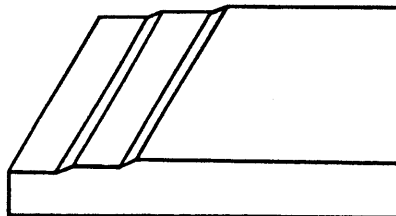

IS 200

Shaped on all 4 sides

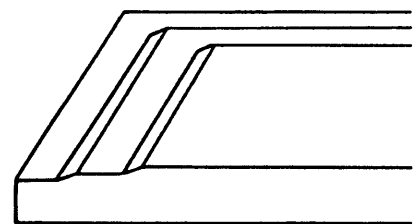

International Series Detail (No additional edge is applied)

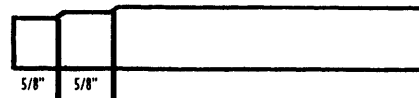

V-GROOVE

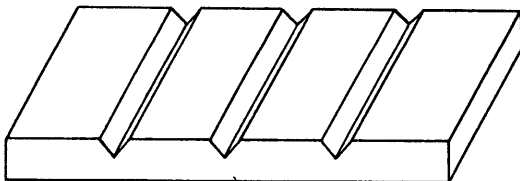

"V" grooves are 2" apart starting at center point of door

RC (Rounded Corner) Doors

The RC Series is a collection of "rounded corner doors." These doors have a 30mm rounded corner in the route profiles but vary according to route depth, width and design. Your choice of standard edge profile is included at no charge. Rounded drawer fronts are available. Slab drawer fronts can also be used.

All RC Series doors are available with either a square panel design or with your choice of six designer panels including a variety of arch and cathedral patterns. See the inside front cover for more information. A small upcharge applies when a designer panel is chosen.

Door	RC 100	RC 200	RC 300	RC 400	RC 500	AVANTI
Minimum Width (Square)	7"	7"	7"	9"	8"	8"
Minimum Width (Arch)	9"	9"	9"	11"	9"	9"
Minimum Width (Cathedral)	10"	10"	10"	12"	10"	10"
Standard Rails & Stiles (Door)	2"	2"	2"	2"	2"	2"
Drawer Front Minimum Height (Standard with 1" top & bottom rails)	5" high	5" high	5" high	7" high	6" high	6" high
Glass Doors Available	YES	YES	YES	YES	YES	YES

Dimensions noted above are for reference only and should be used as a guideline when ordering. Certain minimum height requirements may also be required when ordering Cathedral and Full Round Designs. Unless otherwise noted, all doors are 3/4" thick. All drawings are for illustration and are not drawn to scale.

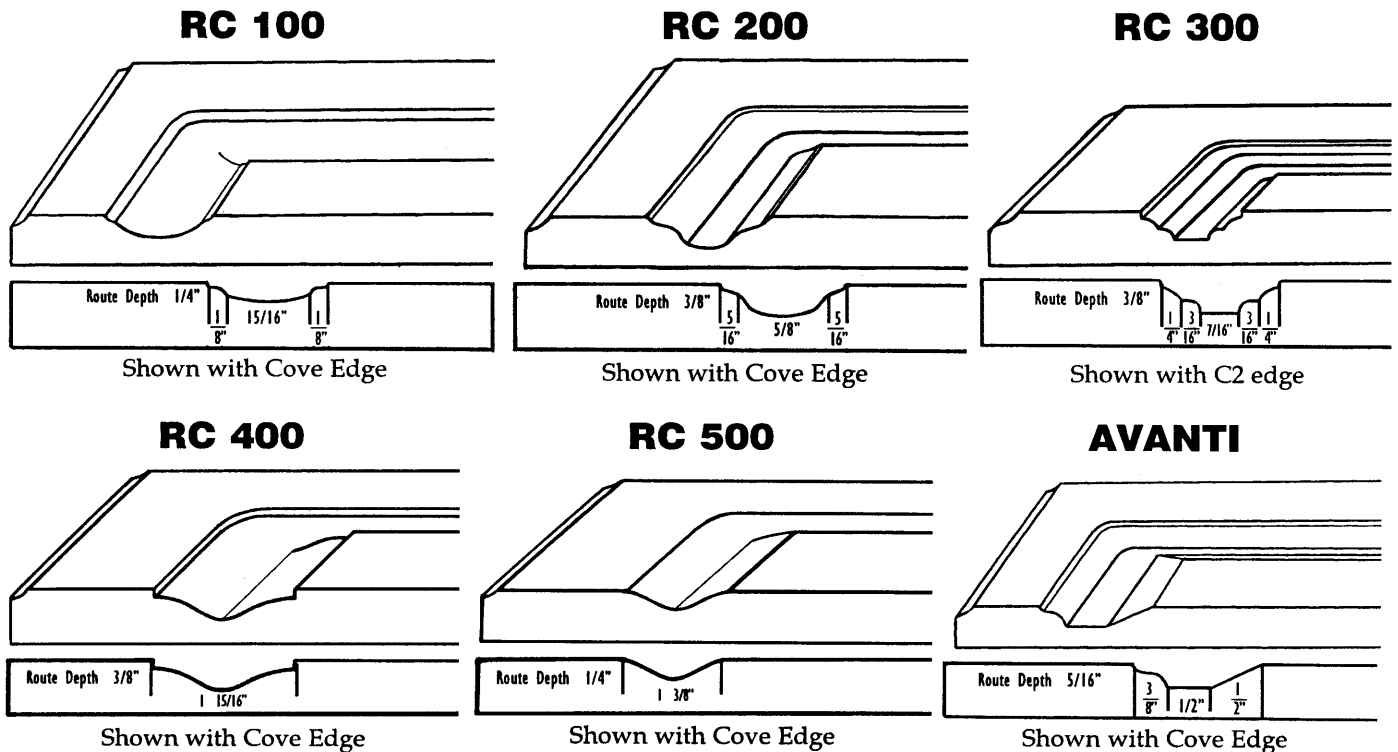

Square Raised Panel Doors

We have a variety of traditional raised panel doors. They include the following door styles.

- > **Lexington** is one of our most popular designs and has a slight (3/32") radius in the route profile.
- > **SQ*** has a cove raised panel and offers our squarest corner.
- > **SQ 300*** has an extra wide route profile and wider rail and stile. Works well with Hedgewood Edge.
- > **Chesapeake*** has a slant raised panel design in the route profile.
- > **BCC** is a cove raised panel with a 45° transition from the rail & stile to the flat part of the route.

Your choice of standard edge profile is available on all doors shown and is included at no charge. Routed drawer fronts are available. Slab drawer fronts can also be used.

All doors shown on this page are available with either a square panel design or with your choice of six designer panels including a variety of arch and cathedral patterns. See the inside front cover for more information. A small upcharge applies when a designer panel is chosen.

*The corners on the SQ and Chesapeake series doors will "fill in" during the foiling process. We recommend ordering a sample before placing your first thermofoil order.

Door	Lexington	SQ	SQ 300	Chesapeake	BCC
Minimum Width (Square)	7"	8"	9"	8"	8"
Minimum Width (Arch)	9"	9"	10"	9"	9"
Minimum Width (Cathedral)	10"	10"	11"	10"	10"
Standard Rails & Stiles (Door)	2"	2"	2 1/2"	2"	2"
Drawer Front Minimum Height	5" high with 1" rails	6" high with 1" rails	6 1/2" high with 1 1/4" rails	6" high with 1" rails	6" high with 1" rails
Glass Doors Available	YES	YES	YES	YES	YES

Dimensions noted above are for reference only and should be used as a guideline when ordering. Certain minimum height requirements may also be required when ordering Cathedral and Full Round Designs. Unless otherwise noted, all doors are 3/4" thick. All drawings are for illustration and are not drawn to scale.

LEXINGTON

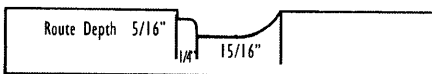
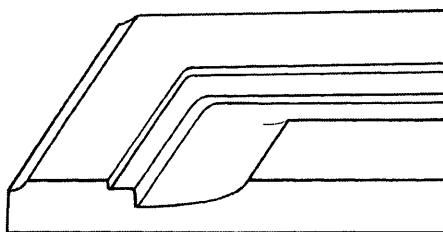

Shown with Cove Edge

SQ

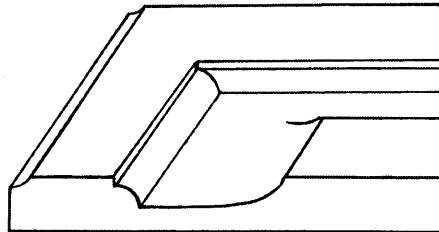

Shown with Cove Edge

SQ 300

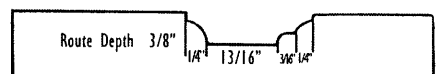
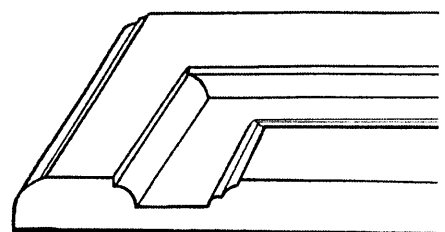

Shown with Hedgewood Edge

CHESAPEAKE

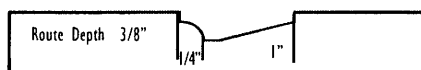
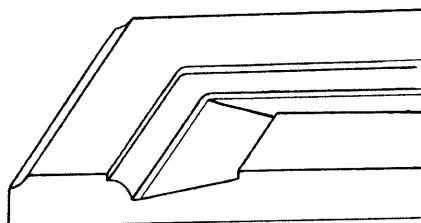

Shown with Cove Edge

BCC

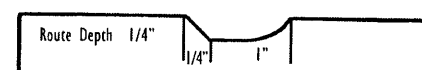
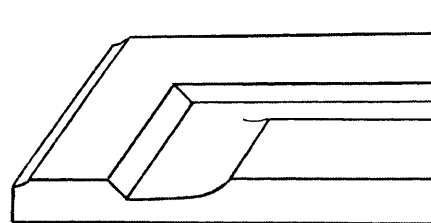

Shown with Cove Edge

Shaker Series

Several Shaker designs are available for your projects. They include:

- > **Shaker #1** has a 90° transition to the flat center panel. This door has a 3/32" radius corner in the route.
- > **Shaker #2** has a bead to the flat center panel.
- > **Shaker #3** has a 45° transition to the flat center panel.
- > **Shaker #4** has a 45° transition to the "v-grooved" center panel.

Due to the manufacturing method, doors over 50" in length should be designed with a middle rail of at least 2" to cure possible warping. To add this middle rail, **YOU MUST** indicate it on your order form. See *Limited Warranty for more information on warping.*

Your choice of standard edge profile is available on all doors shown and is included at no charge. Routed drawer fronts are available. Slab drawer fronts can also be used.

Door	Shaker #1	Shaker #2	Shaker #3	Shaker #4
Minimum Width (Square)	6 1/2"	6 1/2"	6 1/2"	8"
Standard Rails & Stiles (Door)	2 1/4"*	2"	2"	2"
Drawer Front Minimum Height	5" high with 1 1/4" rails	5" high with 1" rails	5" high with 1" rails	5" high with 1" rails
Glass Doors Available	YES	YES	YES	YES

Dimensions noted above are for reference only and should be used as a guideline when ordering. Unless otherwise noted, all doors are 3/4" thick. All drawings are for illustration and are not drawn to scale. All drawings shown with square edge.

Shaker #1

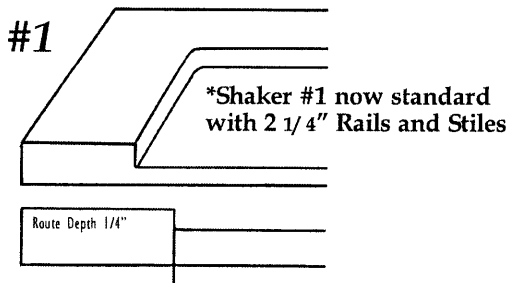

Shaker #2

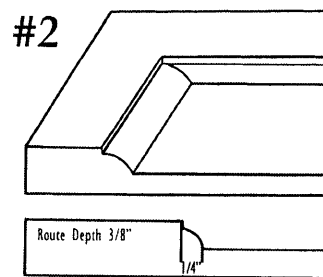

Shaker #3

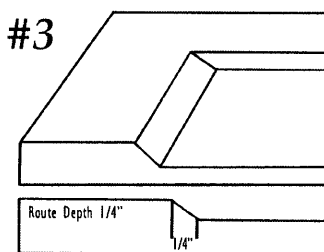

Shaker #4

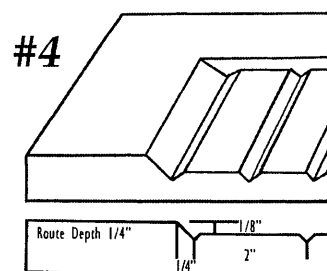

A variety of 5-piece doors is available using several different rail and stile profiles and an assortment of insert panels. These doors offer the look of real wood with the advantages of using MDF. Woodgrain doors will follow the pattern of a real wood door with horizontal top and bottom rails. The 2000 Series is also available with a glazed finish (see page 9).

There will be a visible mitre joint on all vinyl doors because the components of the door (rails, stiles, inserts) are foiled and then assembled. On painted or primed doors, this joint may or may not be visible.

Due to the manufacturing method used, there are several limitations that must be taken into consideration.

- > No arches are available - square panels only
- > No double panels
- > No raised panel drawer fronts - use flat inserts or bead board only
- > No rail or stile changes
- > Your choice of standard edge on 2003 & 2004 series only.
- > Heights over 36" will require additional hinges or preparation to cure warpage.

Door	2000	2001	2002	2003	2004	2005	2006
Minimum Width (Square)	10"	10"	10"	10"	10"	10"	10"
Standard Rails & Stiles (Door)	2 5/16"	2 5/16"	2 7/8"	2 5/16"	2 5/16"	2 7/8"	2 1/4"
Standard Rails (Drawer Front)	See above	See above	2 5/16"	See above	See above	2 5/16"	See above
Drawer Front Minimum Height	6" high	6" high	6" high	6" high	6" high	6" high	6" high
Available with Rope Trim	YES	NO	NO	NO	NO	NO	YES
Glass Doors Available	YES	YES	YES	YES	YES	YES	YES

Dimensions noted above are for reference only and should be used as a guideline when ordering. All drawings are for illustration and are not drawn to scale. Dimensions below include all beads. The thickness of center panels may vary according to style, finish, etc. If a dimension is critical, please call for more information. See individual rail and stile dimensions for overall thickness of door.

-----Step #1 - Choose a Rail and Stile-----

2000 Series

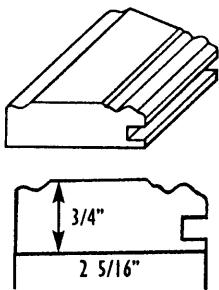

2001 Series

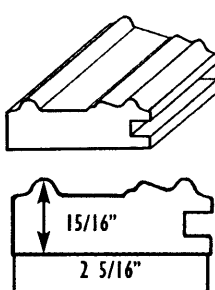

2002 Series

A modified rail and stile (2002DF) is used for drawer fronts in this series.

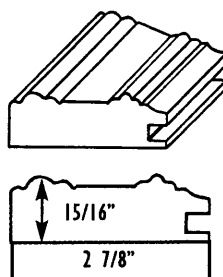

2003 Series

Your choice of edge is available on this door

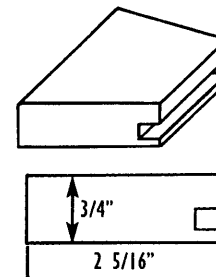

2004 Series

Your choice of edge is available on this door.

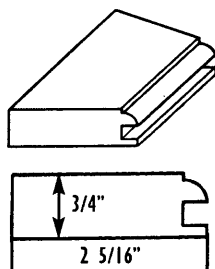

2005 Series

A modified rail and stile (2005DF) is used for drawer fronts in this series. Available with 1/8" Roundover or Square Edge

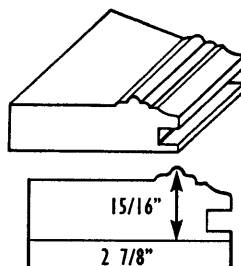

2006 Series

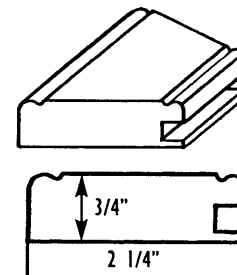

-----Step #2 - Choose an Insert Panel-----

All drawings are for illustration only and are not to scale.

Bead Board

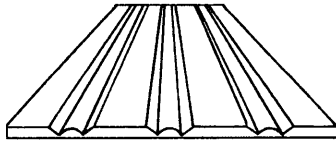

Beads are 1 1/4" on center

Flat Panel

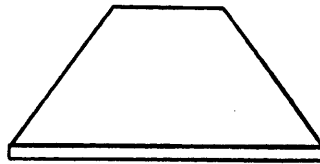

Cove Raised Panel

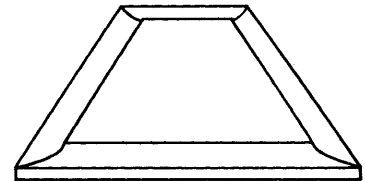

Colonial Raised Panel

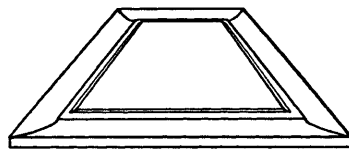

Slant Raised Panel

Available with 2001, 2002 & 2005 only

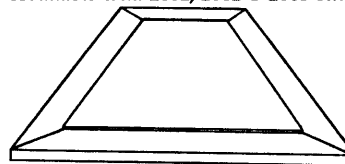

Back of Door Detail

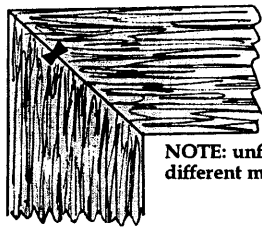

NOTE: unfinished doors may be assembled using a different method instead of the dovetail shown.

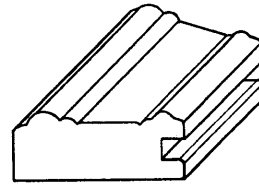

2002 DF

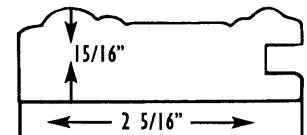

Illustration of 2002DF Drawer Front

Glazed Finishes

We are now offering a glazed finish on our 2000 series door. We are currently offering 4 glaze combinations including Almond, Amber, Mahogany and Van Dyke Brown. These glazes may not be available on all foils. Please call for more information or to request a sample. (Rope trim cannot be glazed).

Glaze can also be applied to the bead board insert and to the top edge of the Colonial Raised Panel insert. We can also apply glaze to the 4" Top Mount Crown and 3 5/8" Crown moldings. No glaze can be applied to slab fronts.

As with all glazed items, the finish may vary from time to time. Subtle differences are not considered to be defects and are the very nature of glazed products. So long as no error or problem has occurred in the glazing process, no refunds or adjustments will be made.

A variety of moldings and miscellaneous items is available to complement your designs. Moldings are sold in 8 foot lengths. All drawings included are for illustration only and are not drawn to scale.

Crown Moldings

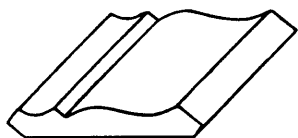

3 5/8" Crown Molding
This crown also available in
4 5/8" and 5 5/8" sizes



5 1/2" Crown Molding



4" Top Mount Crown

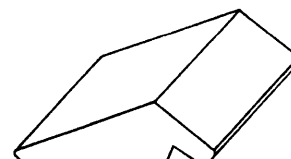

Shaker Top Mount

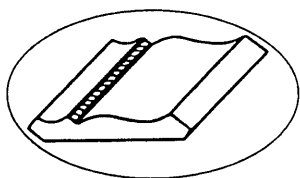

5 5/8" Crown Molding
(Also available with
Rope Trim)

Cove Molding

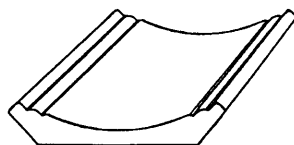

4 3/8" Cove

Base Molding

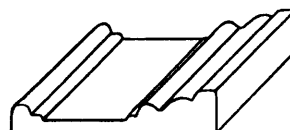

3 1/2" Base/Door

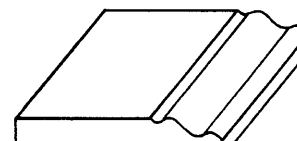

4" Traditional Base

Fluted and Beaded Molding

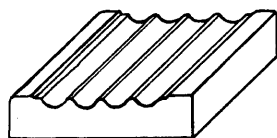

3" Stock Flute

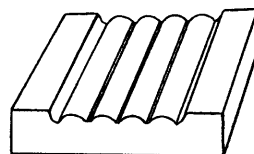

3 1/2" 4-Bead Molding

Light Rails

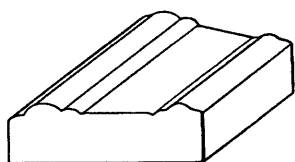

2002DF Light Rail

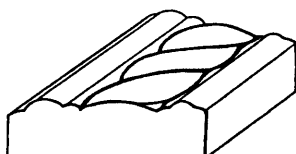

2002DF Rope Light Rail

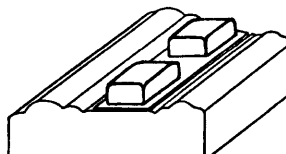

2002DF Dentil Light Rail

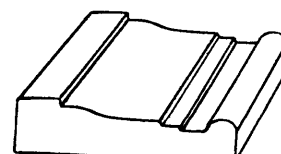

2 1/2" Molded Light Rail

Misc. Trim Moldings and Accessories

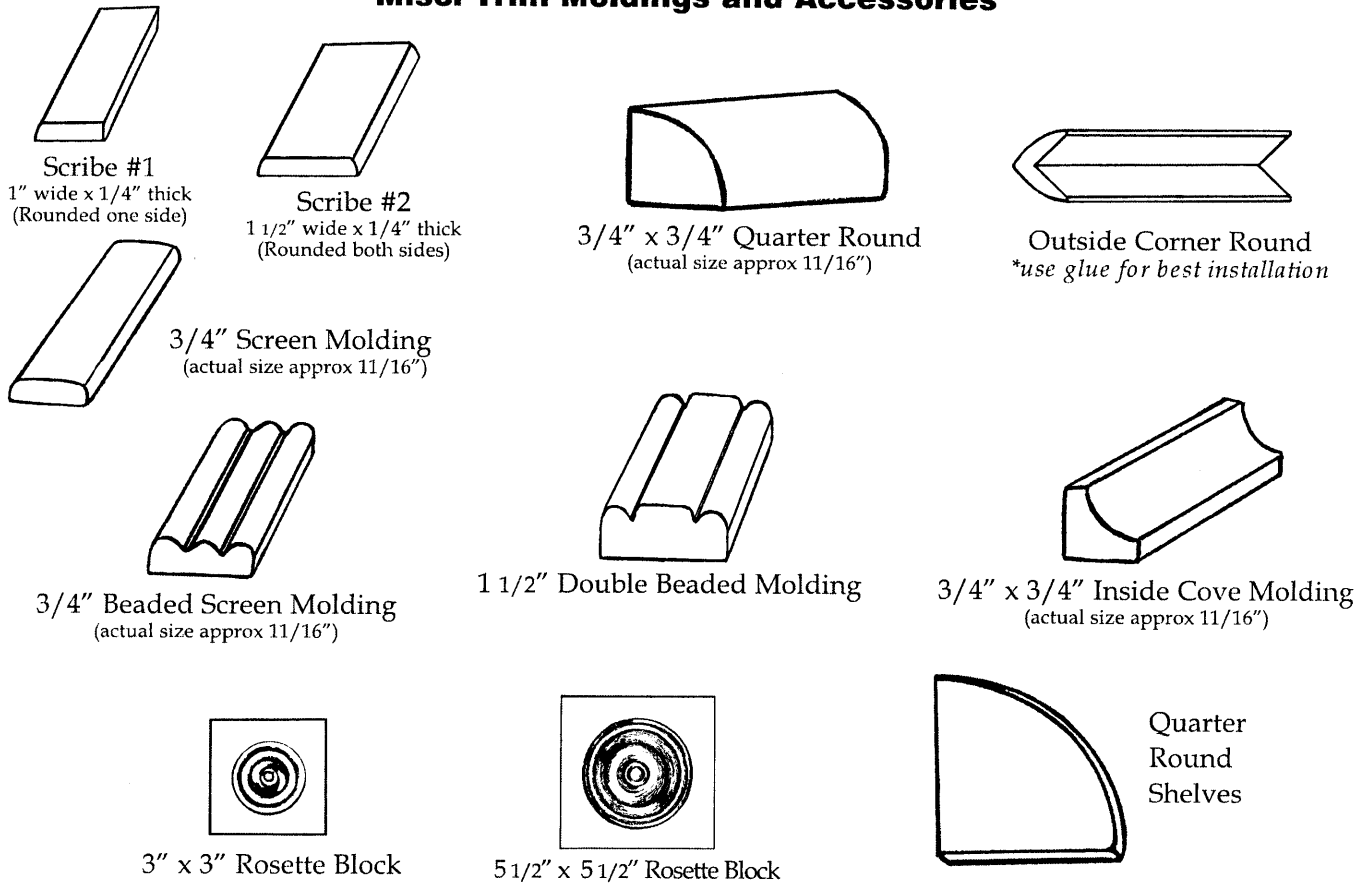

Bead Board - We can supply you with 1/4" bead board for use as end panels, back panels, etc. The maximum size is 24" x 96". Different thicknesses may be available. Please inquire.

Foil Material - Foil can be purchased to cover your cabinet boxes and end panels. This material averages between 50" to 57" in width and linear footage can be rolled off per your instructions. Remember to take grain patterns into consideration and order sufficient amount to complete your installations. This material can be applied using a variety of methods ranging from countertop glues, contact cement or solvent-based sprays. We suggest you try a small area before attempting a large installation. Manufacturer offers these suggestions for your consideration and assumes no responsibility or guarantee regarding these methods of application.

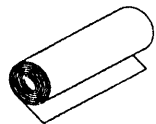

Headers and Valances - Decorative headers and arch valances can be purchased for your installations. Since programs are already established for the production of these Header pieces, a design fee must be charged for any modifications to the overall design. When ordering valances, you must specify the width of the "legs" and the center dimension as shown on drawing. If a specific radius is required, a design fee may be charged. All sizes may not be available in thermofoil because of woodgrain considerations.

Header

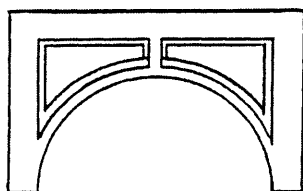

Valance

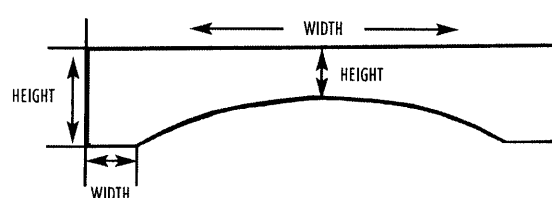

Glass doors are available to complement your designs including open frame (**Prism**) doors and mullion/grid (**Optical Series**) doors. All glass doors are standard with a 1/2" rabbeted back. No glass or hardware is provided for your installation. When ordering, specify the door style and edge to match your doors - for example, if you are ordering Lexington Series doors, order Lexington Series glass doors. All drawings are for illustration only and are not to scale. See the individual door series to determine minimum and maximum requirements.

Prism Doors

We recommend a center rail of 2" or more on prism doors that are over 50" in length, however, **you must request this** on your order form.

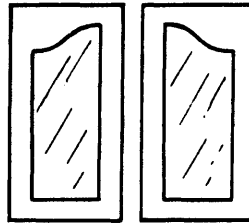
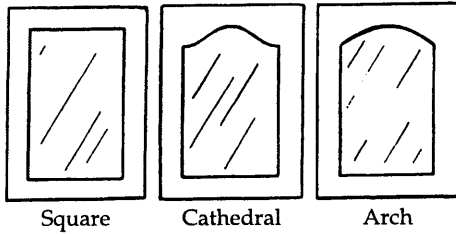

Split Cathedral
(Order as 2 doors - 1 left/1 right)
Split Full Round also available.

Optical Doors

Here are a few samples of available glass door configurations.

4 LIGHT SQUARE

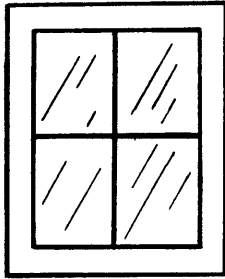

4 LIGHT ARCH

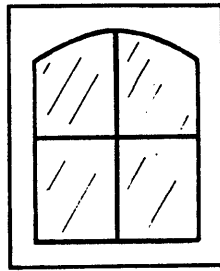

4 LIGHT FULL ROUND

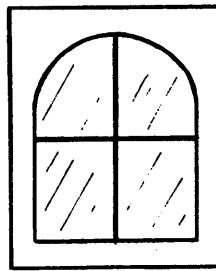

4 LIGHT PROVENCIAL

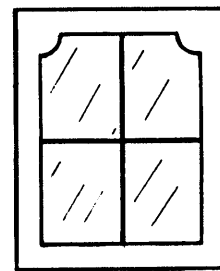

6 LIGHT CATHEDRAL

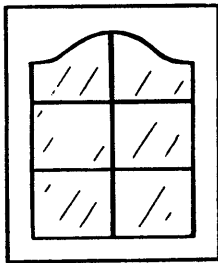

9 LIGHT ARCH*

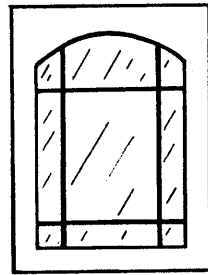

9 LIGHT SQUARE*

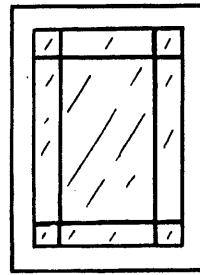

9 LIGHT SPLIT FULL ROUND*
(Order as 2 doors 1 left/1 right)

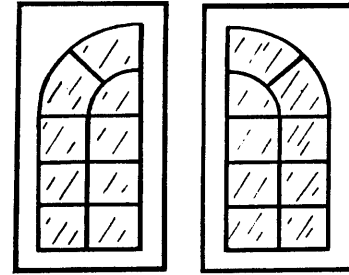

8 LIGHT SQUARE

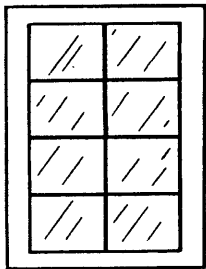

8 LIGHT CATHEDRAL

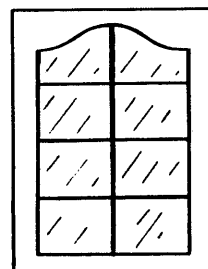

10 LIGHT FULL ROUND*

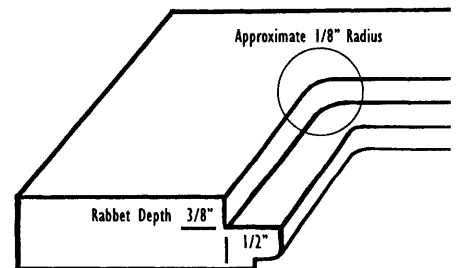
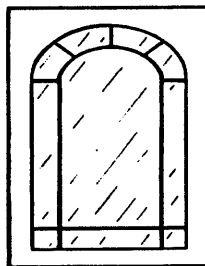

Sample of Standard Rabbit for Optical and Prism Doors

*MINIMUM 14" WIDTH

Order Information

Acknowledgements – An order acknowledgement is produced for every order. Acknowledgements show the type of door style, quantities, sizes and approximate shipping dates. Customers with fax machines will generally be faxed an acknowledgement within 24 hours; otherwise, acknowledgements will be mailed. ***In all cases, it is the customer's responsibility to review acknowledgements and report errors and omissions immediately.*** USCF may require that you sign off on an order before production can begin. REMINDER: If you don't receive an acknowledgement, let us know immediately – this may mean that we didn't receive your order or that there was some problem in entering the information.

Cartoning Fees – This fee is charged to help defray the cost of our foam packaging system and our packing department personnel. Our foam packaging system is very effective and has virtually eliminated instances of freight damage. These fees are based on a percentage of the total order. A minimum fee will be charged on small orders. On orders USCF deems appropriate for LTL (truck line) shipping, additional cartoning fees may be assessed when a UPS only delivery is requested. In all cases, freight charges are in addition to cartoning fees. Products are shipped FOB, Suwanee, Georgia.

Changing an Order – Orders are generally in production within 24 hours. Changes will be accepted up to two working days after an order is placed. Any charges associated with such change (unless a result of our error) will be passed to the customer. Due to the disruption in workflow, changes may not be made after three working days. **NOTE: CHANGES WILL NOT BE ACCEPTED ON RUSH ORDERS.**

COD Fees – UPS and the various freight lines charge COD fees when money has to be collected on delivery to pay for your products. This fee is included in your freight bill and can be avoided by prepaying orders or by paying with credit card. These fees will vary but please know that USCF has negotiated a discounted fee with many of the freight companies.

Collect Freight – USCF ships LTL (truck shipments) Freight Collect whereby the freight company collects money owed to them for the transport of goods from our plant in Suwanee, Georgia to your location. We have negotiated with all our carriers to receive discounted rates. If you would like to request a particular carrier, please call our shipping department.

Credit Cards – USCF accepts credit cards for payment of products and services. Visa, MasterCard, American Express and Discover can be used. Most check cards are also acceptable. Credit card charges are processed on the day of shipping.

Deposits – A deposit of 50% may be requested on all painted jobs and/or jobs requiring special tooling and/or materials. At USCF's discretion, production can begin pending arrival of this 50% deposit. First time orders require that a deposit of 50% be received in certified funds (or credit card) before production can begin.

Design Fee – USCF currently has 2 CNC routers that allow us to produce a variety of designs and custom programs. If you have a special project, please contact our office. We can review your information and provide a quotation on your designs. A design fee may be charged depending on the difficulty of your particular project and at the discretion of U.S. Customized Finishes, Inc. Generally this fee will be due in advance and (in most cases) will include a small unfinished prototype to be sent for your approval.

Lead Times – Approximate shipping dates are shown on your acknowledgements. While every effort is made to ship products on this estimated date, no guarantee is given or implied. General lead times are posted on our website at www.uscustomized.com.

Minimums – There is no minimum order requirement, however a minimum cartoning fee will be assessed for all shipped orders.

Ordering – Order forms are available and can be copied for your convenience. We prefer that orders be faxed to avoid error, however phone orders will be accepted. Phone orders will be repeated back and then considered to be correct. In the event of dispute, our written listing will be considered to be the correct listing of sizes. We will no longer make adjustments on telephone orders when there is a dispute over sizes. In some cases, we may require that you sign off on an order before production can begin.

Payment – All orders are shipped on a COD basis unless payment has been made in advance by check or credit card. Certified checks may be required for first time customers. See the Customer Information sheet included in this booklet. In no event shall an order be held more than 5 days past the estimated shipping date waiting on payment. On the 6th day, the shipment will be sent COD, Certified Check. All fees associated with this method of shipment will defer to the customer.

Purchase Orders – We prefer to have a purchase order or job name to reference your particular order. This way we can easily check your orders and provide information to you when needed. If provided, this information will be shown on your acknowledgement.

Rush Jobs – We understand that from time to time some jobs may require special attention. Due to the increasing strain that these jobs put on our schedule, a 20% rush fee (or \$10 minimum) will be charged on these orders. NOTE: No changes will be allowed on rush jobs once orders are in production.

Shipping Costs – It is very difficult to estimate shipping costs on an order because of the many variables involved (including weight and distance). Generally, weight for a particular shipment can be "guesstimated" at 3 lbs per square foot. Please let us use our best judgement to ship your products economically and safely.

MDF DOOR ORDER FORM

Use this order form for ordering MDF doors.

DATE _____ P.O.# _____ CONTACT _____

CUSTOMER _____

ADDRESS _____

CITY _____ STATE _____ ZIP _____

TELEPHONE _____ FAX NUMBER _____

Circle your selections from the categories listed below and to the right. Please fill out completely to avoid order delays.

Page _____ of _____
Quote Order Please circle one. Unless quote is clearly marked, we will release this order for production.
Rush Fee YES NO 20% Rush Fee added to order. \$10 minimum.

Flat Panel Doors		Edge	Glass <i>Glass not provided</i>	Specify Finish Circle one choice from each column		Payment Method
Classic (Slab) IS 100		C2	To avoid confusion, please order glass doors on a separate page.	Front	Back	Prepay COD
V-Groove IS 200				Raw MDF	Raw MDF	Credit Card Credit Card
RC (Rounded Corner) Doors Circle door series and panel design		#10 Cove	Please Specify: 1. Door Style 2. Design 3. Number of Openings Open Frame 2 Lites 4 Lites 6 Lites 8 Lites 9 Lites 10 Lites Other	Primed MDF	Primed MDF	On File Below
RC 100	RC 200	#20 1/4" Round		Frosty White PAINT	White Melamine	Expiration
RC 300	RC 400	#30 1/4" Round with 1/16" Reveal		Antique White PAINT	Painted White	
RC 500	Avanti	1/8" Round		Almond PAINT	Painted Antique	Alternate Ship Address? If yes, write below.
Square Raised Panels Circle door series and panel design		#50 Square		Thermofoil Specify face and back color from color chart	Glaze (If available, applied to thermofoil only)	Telephone #
Lexington	Chesapeake	Hedgewood		Face:	Almond	
SQ	BCC	Italia		Back:	Amber	Preferred* Ship Method
SQ 300		Other		Match Face* <input type="checkbox"/>	Mahogany	Forklift? Yes No
Shaker Doors Circle door series		Notes:		White Back <input type="checkbox"/>	Van Dyke Brown	UPS LTL PICK BEST UP WAY
Shaker #1	Shaker #2			Other*		*If possible, preferred method will be used. Due to size limitations, some orders cannot ship UPS. Orders best suited for LTL shipment will be subject to additional fees if box count exceeds usual & customary.
Shaker #3	Shaker #4		*if available. If no back treatment is chosen, white back will be used. <div style="border: 1px solid black; padding: 5px; display: inline-block;"> Doors - Vertical Grain application Drawer Fronts - Horizontal Grain </div>			

5-Piece Doors - Circle door series and insert		QTY	WIDTH X HEIGHT	NOTES	QTY	WIDTH X HEIGHT	NOTES
Door Series	Panel Insert	1	X		16	X	
2000 Series	Flat Panel	2	X		17	X	
2001 Series	Bead Board	3	X		18	X	
2002 Series	Colonial Raised	4	X		19	X	
2003 Series	Cove Raised	5	X		20	X	
	Specify Edge	6	X		21	X	
2004 Series	Slant Raised (2001, 2002, 2005 Only)	7	X		22	X	
	Specify Edge	8	X		23	X	
2005 Series	None (Glass Door)	9	X		24	X	
	Specify Edge	10	X		25	X	
	4-Light Grid(Glass)	11	X		26	X	
2006 Series	6-Light Grid(Glass)	12	X		27	X	
	8-Light Grid(Glass)	13	X		28	X	
Please include a drawing if you are ordering intricate panels or special configurations.		14	X		29	X	
Notes		15	X		30	X	

It is the customer's responsibility to check acknowledgements for accuracy.
Report any errors immediately.

MDF DRAWER FRONTS ORDER FORM

Use this order form for ordering MDF drawer fronts.

DATE _____ P.O.# _____ CONTACT _____

CUSTOMER _____

ADDRESS _____

CITY _____ STATE _____ ZIP _____

TELEPHONE _____ FAX NUMBER _____

Circle your selections from the categories listed below and to the right. Please fill out completely to avoid order delays.

Page _____ of _____	
Quote	Order
Please circle one. Unless quote is clearly marked, we will release this order for production.	
Rush Fee	
YES	NO
20% Rush Fee added to order. \$10 minimum.	

Flat Panel Drawer Fronts			Edge		Specify Finish Circle one choice from each column		Payment Method	
Classic (Slab)	IS 100		C2	#10 Cove	Front	Back	Prepay	COD
V-Groove	IS 200				Raw MDF	Raw MDF	Credit Card	Credit Card
RC (Rounded Corner) Drawers Circle door series			Drawer Front	#20 1/4" Round	Primed MDF	Primed MDF	On File	Below
RC 100	RC 200	Most 1-Piece raised drawer fronts will have 2" stiles and 1" rails unless you have specified otherwise. (Note: See SQ 300 info for rail and stile detail.) 2" 1" 2" 1"	#30 1/4" Round with 1/16" Reveal	Frosty White PAINT	White Melamine	Expiration		
RC 300	RC 400		1/8" Round	Antique White PAINT	Painted White	Alternate Ship Address? If yes, write below.		
RC 500	Avanti		#50 Square	Almond PAINT	Painted Antique			
Square Raised Panel Drawer Fronts Circle door series			Notes:	Hedgewood	Thermofoil Specify face and back color from color chart	Glaze (If available, applied to thermofoil only)	Telephone #	
Lexington	Chesapeake		Italia	Face:	Almond	Preferred* Ship Method		
SQ	BCC		Other	Back:	Amber	Forklift?	Yes No	
SQ 300				Match Face* <input type="checkbox"/>	Mahogany	UPS	LTL PICK BEST UP WAY	
Shaker Drawer Fronts Circle door series				White Back <input type="checkbox"/>	Van Dyke Brown	*If possible, preferred method will be used. Due to size limitations, some orders cannot ship UPS. Orders best suited for LTL shipment will be subject to additional fees if box count exceeds usual & customary.		
Shaker #1	Shaker #2			Other*				
Shaker #3	Shaker #4			*if available. If no back treatment is chosen, white back will be used. Doors - Vertical Grain application Drawer Fronts - Horizontal Grain				

5-Piece Drawer Fronts Circle door series and insert		QTY	WIDTH X HEIGHT	NOTES	QTY	WIDTH X HEIGHT	NOTES
Door Series	Panel Insert	1	X		16	X	
2000 Series	Flat Panel	2	X		17	X	
2001 Series	Bead Board	3	X		18	X	
2002 Series	None	4	X		19	X	
2003 Series	Specify Edge	5	X		20	X	
2004 Series		6	X		21	X	
2005 Series		7	X		22	X	
2006 Series		8	X		23	X	
		9	X		24	X	
		10	X		25	X	
		11	X		26	X	
	12	X		27	X		
	13	X		28	X		
	14	X		29	X		
	15	X		30	X		

Please include a drawing if you are ordering intricate panels or special configurations.

Notes

It is the customer's responsibility to check acknowledgements for accuracy. Report any errors immediately.

MDF MOLDING ORDER FORM

Use this order form for molding and misc. items.

DATE _____ P.O.# _____ CONTACT _____

CUSTOMER _____















ADDRESS _____

CITY _____ STATE _____ ZIP _____

TELEPHONE _____ FAX NUMBER _____

Page _____ of _____
Quote Order Please circle one. Unless quote is clearly marked, we will release this order for production.
Rush Fee YES NO 20% Rush Fee added to order. \$10 minimum.

Circle your selections from the categories listed below and to the right. Please fill out completely to avoid order delays.

Quantity Sticks/Pieces	Description (Moldings sold in 8' lengths)	Specify Finish	Payment Method
	3 5/8" Crown 	Raw MDF	Prepay COD Credit Card Credit Card On File Below
	4 5/8" Crown 		
	5 5/8" Crown 		
	5 5/8" Crown w/Rope Trim 	Primed MDF	Expiration _____
	5 1/2" Crown 		
	4 3/8" Cove 		
	4" Top Mount 	Painted MDF Frosty White Antique White Almond	Alternate Ship Address? If yes, write below.
	Shaker Top Mount 		
	3 1/2" Base/Door Trim 		
	4" Traditional Base 	Thermofoil Specify Foil Color from Color Chart	Telephone # _____ Preferred* Ship Method Forklift? Yes No UPS LTL PICK BEST UP WAY
	3 1/2" 4-Bead Molding 		
	3" Stock Flute 		
	Custom Flute _____ w X _____ h Start & Stop points _____ (If nothing marked, flutes will run length of piece)	Glaze Finish (added to Thermofoil Color above) Almond Amber Mahogany Van Dyke Brown	*If possible, preferred method will be used. Due to size limitations, some orders cannot ship UPS. Orders best suited for LTL shipment will be subject to additional fees if box count exceeds usual & customary.
	Custom Flute with Routed Rosettes _____ w X _____ h Start & Stop points _____ Rosettes will be centered in remaining space at top and bottom unless otherwise specified.		
	3" x 3" x 1" Rosette Block		
	5 1/2" x 5 1/2" x 1" Rosette Block	Miscellaneous	Sample Packs
	9" x 5" x 1" Plinth Block Edge Instructions?		
	2002DF Light Rail (Plain)	Bead Board	Qty _____
	2002DF Light Rail w/Dentil Accent	No. of Sheets _____ (24" w x 96" h sheets unless specified)	Unfinished Pack
	2002DF Light Rail w/Rope Accent	Foil Material (Specify Color) _____	Thermofoil Pack #1
	2 1/2" Molded Light Rail	Average 50" w x _____ lineal ft.	Thermofoil Pack #2
	1" Scribe 	Header (See page 11 for more information.)	Primed/Finished Pack
	1 1/2" Scribe 		Glazed Sample Pack
	3/4" Screen Molding	Valance (See page 11 for more info. Specify all dimensions and edge instructions to avoid delay.)	Deluxe Sample Pack
	3/4" Beaded Screen Molding		
	1 1/2" Double Beaded Molding		
	3/4" Quarter Round		
	Outside Corner Round		
	3/4" Inside Cove Molding		
	Quarter Round Shelves		

It is the customer's responsibility to check acknowledgements for accuracy.
Report any errors immediately.

Customer Information Sheet

Please copy this page and return the completed sheet with your first order. This information will allow us to properly administer your account. Prompt submission will also allow us to accept company checks for your purchases. Certified checks may be required until this information form is returned. This is not an application for open account.

Company Name _____

Mailing Address _____

City _____ State _____ Zip _____

Ship Address (if different) _____

City _____ State _____ Zip _____

Telephone _____ Fax Number _____

e-mail address _____ Type of Business _____

Sales Tax Exemption Number _____ Ga. Customers please attach a valid certificate. Customers who pick up orders at our location are required by law to pay appropriate sales taxes unless a sales tax exemption certificate is on file. As of this writing, shipments traveling out of state via common carrier are not subject to sales taxes. At this time, manufacturer is not authorized to collect sales taxes in other states and thereby transfers the responsibility to the purchaser to report any applicable purchases to the local taxing authority.

Management Contact _____ Title _____

Sales Contact _____ Title _____

Bank Name _____ Banker _____ Acct.# _____

Trade Reference #1 _____
Name _____ City, State _____ Telephone _____ Fax _____

Trade Reference #2 _____
Name _____ City, State _____ Telephone _____ Fax _____

Trade Reference #3 _____
Name _____ City, State _____ Telephone _____ Fax _____

To pay by credit card, please complete the following.



Cardholder Name _____ Signature _____

Card Number _____ Exp. Date _____

Unless notified otherwise, this credit card will be used for all purchases made by your company.

A receipt for your credit card transaction will be sent with each invoice.

Manufacturer reserves the right to refuse any order for any reason and to require payment in advance of production when and if it deems appropriate. There will be a \$25.00 returned check fee for any and all returned checks and a 1 1/2% finance charge will be assessed on any outstanding balances created by such a default. Collection services will be employed whenever necessary and all fees associated with such collection will be passed to the customer. Certified checks will be required for all accounts with prior bad experience (including bounced check, stop pay, etc.) Signature indicates your understanding and acceptance of the terms and conditions noted above as well as those outlined in the General Information section of this catalog.

Signature _____ Date _____

Limited Warranty

Manufacturer provides a one year limited warranty for all painted MDF products. A 3-year limited warranty applies to thermofoiled products. Finished products (both paint and foil) are produced using materials that contain UV protectants to reduce the possibility of yellowing. However, as with any product, certain changes will take place over time and can be affected by factors such as sunlight, smoke, and cleaning products. Our white colors will "gray" over time and this change in color is not considered to be a defect of the product. Raw and primed doors carry no warranty for finishing.

Thermofoil doors that are placed next to an oven unit should be kept open during the cleaning cycle when extremely high temperatures are present. Opening adjacent doors will allow the heat to dissipate and help prevent delamination of the vinyl from the MDF substrate. During the thermofoil process, slight imperfections will occur. These imperfections may include elevations of the foil, depressions in the substrate, bridging of the vinyl or machining lines. Generally if these imperfections are not visible in normal kitchen lighting, they will not be considered to be defects.

All doors 21" or less wide and 45" or less tall carry a full warranty against warpage. (Squareness width and height of more than 1/8".) Doors or panels over 21" wide or 45" high carry no warranty against warpage. Raw and primed doors carry no warranty for warpage since finishing techniques can affect the outcome of these products.

All products are guaranteed to be within 1/16" of the size ordered. This 1/16" tolerance is an industry standard. Generally, products received will be the exact size ordered.

Shortages should be reported within 5 days of receipt. No claims for shortage will be accepted after 30 days.

Any item(s) claimed to be defective must be reported within 5 days of receipt. No claims for damage will be accepted after 30 days. Items claimed to be defective must be returned for inspection at our request. Repair or replacement parts are provided. No accommodation for labor for removing parts or installation of new parts will be given. Warranty will not apply to improper storage, handling, or finishing on the part of the customer. Improper handling also includes abuse, misuse, and incorrect installation on the part of the contractor.

Manufacturer will not be held responsible for delays caused by unavoidable accidents, transportation strikes, or other matters that are beyond our control. Warranty does not apply to freight damage. Damage should be reported to the truck driver at delivery and you should make sure that a notation is made on the bill of lading to assure that a freight claim can be filed and processed without delay. If the carton is damaged and you suspect damage to the contents, make the driver wait until you have had an opportunity to examine the product. Failure to note damage on delivery greatly reduces the chance for reimbursement. In the event that you have freight damage, please contact the freight company for advice and assistance.

U.S. Customized Finishes, Inc., 1175 Hwy 23, Ste. 8, Suwanee, Georgia 30024
Telephone # (770) 271-1266 Fax # (770) 271-8793 or (800) 473-1462
E-mail: uscf@uscustimized.com Web Site: www.uscustimized.com